

EURO-PRO **ONE (1) YEAR LIMITED WARRANTY**

EURO-PRO Operating LLC warrants this product to be free from defects in material and workmanship for a period of one (1) year from the date of the original purchase, when utilized for normal household use, subject to the following conditions, exclusions and exceptions.

If your appliance fails to operate properly while in use under normal household conditions within the warranty period, return the complete appliance and accessories, freight prepaid to

EURO-PRO Operating LLC, 94 Main Mill Street, Door 16, Plattsburgh, N.Y. 12901

If the appliance is found to be defective in material or workmanship, **EURO-PRO Operating LLC** will repair or replace it free of charge. Proof of purchase date and \$ 12.95 to cover the cost of return shipping and handling must be included.*

Non-durable parts including, without limitation, dust cup filters, filters, brushes and electrical parts which normally require replacement are specifically excluded from warranty.

The liability of **EURO-PRO Operating LLC** is limited solely to the cost of the repair or replacement of the unit at our option. This warranty does not cover normal wear of parts and does not apply to any unit that has been tampered with or used for commercial purposes. This limited warranty does not cover damage caused by misuse, abuse, negligent handling or damage due to faulty packaging or mishandling in transit. This warranty does not cover damage or defects caused by or resulting from damages from shipping or repairs, service or alterations to the product or any of its parts, which have been performed by a repair person not authorized by **EURO-PRO Operating LLC**.

This warranty is extended to the original purchaser of the unit and excludes all other legal and/or conventional warranties. The responsibility of **EURO-PRO Operating LLC** if any, is limited to the specific obligations expressly assumed by it under the terms of the limited warranty. **In no event is EURO-PRO Operating LLC** liable for incidental or consequential damages of any nature whatsoever. Some states do not permit the exclusion or limitation of incidental or consequential damages, so the above may not apply to you.

This warranty gives you specific legal rights, and you may also have other rights which vary from state to state.

***Important: Carefully pack item to avoid damage in shipping. Be sure to include proof of purchase date and to attach tag to item before packing with your name, complete address and phone number with a note giving purchase information, model number and what you believe is the problem with item. We recommend you insure the package (as damage in shipping is not covered by your warranty). Mark the outside of your package "ATTENTION CUSTOMER SERVICE". We are constantly striving to improve our products, therefore the specifications contained herein are subject to change without notice.**

Shark[™]
CORDLESS hand vac
wet/dry

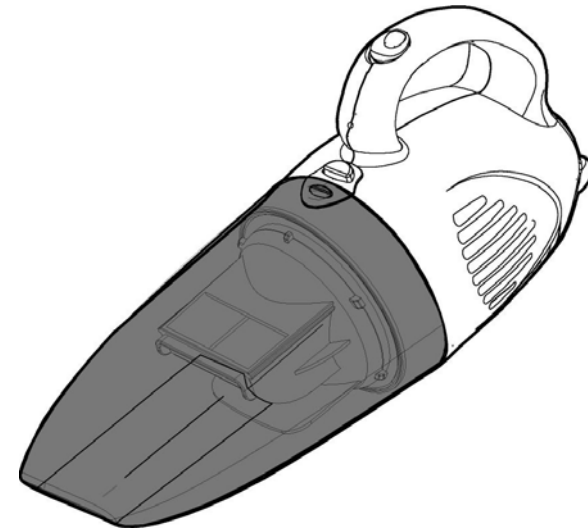
USE & CARE INSTRUCTIONS**Model SV745****14.4 V DC**

EURO-PRO Operating LLC
94 Main Mill Street, Door 16
Plattsburgh, NY 12901
Tel.: 1-866-98SHARK
(1-866-987-4275)
www.sharkvac.com

EURO-PRO 

IMPORTANT SAFEGUARDS

When using an electrical appliance, basic safety precautions should always be observed, including the following

READ ALL INSTRUCTIONS BEFORE USING YOUR CORDLESS WET/DRY HAND VACUUM.

WARNING:

To reduce the risk of fire, electrical shock, or injury:

1. Do not charge this unit outdoors.
2. Do not use outdoors.
3. Do not allow to be used as a toy. Close attention is necessary when used by or near children.
4. Use only as described in this manual. Use only manufacturer's recommended attachments.
5. Do not use charger if power cord has been damaged. Do not use cordless wet/dry hand vacuum or charger if it has been dropped, damaged, left outdoors, or dropped in water. Return it to **EURO-PRO Operating LLC** for examination, repair or adjustment.
6. Do not abuse the charger cord. Never carry the charger or base by the cord or yank to disconnect from an outlet; instead grasp the plug and pull to disconnect.
7. Keep charger cord away from heated surfaces.
8. This product includes rechargeable nickel cadmium batteries. Batteries must be recycled or disposed of properly. **Do not incinerate batteries or expose to high temperatures**, as they may explode.
9. Do not handle plug or appliance with wet hands.
10. Do not put any object into openings. Do not use with any opening blocked; keep free of dust, lint, hair and anything that may reduce air flow.
11. Keep hair, loose clothing, fingers, and all parts of body away from openings and moving parts.
12. Do not pick up anything that is burning or smoking, such as cigarettes, matches, or hot ashes.
13. Do not attempt to change accessories while unit is running.
14. Use extra care when cleaning on stairs.
15. **Do not use to pick up flammable or combustible liquids such as gasoline or use in areas where they may be present.**
16. Look on your wet/dry hand vacuum and follow all label and marking instructions.
17. Do not use charger with an extension cord. Plug charger directly into an electrical outlet. Use charger only in a standard (120V., 60Hz) electrical outlet.
18. **Do not use the wet/dry hand vacuum cleaner without dust cup filter and separator in place.**
19. Store the wet/dry cordless vacuum indoors. Put the cordless vacuum away after use to prevent accidents.
20. When vacuuming up liquids, ensure that you do **NOT** go over the "MAX" level on the dust cup. (Capacity is 6 US Fl. Oz.)
21. Always empty the dust cup after using the vacuum to pick up liquids.
22. Leaks from battery cells can occur under extreme conditions. If the liquid, which is 20-35% solution of potassium hydroxide, gets on the skin - wash immediately with soap and water or neutralize with a mild acid such as lemon juice or vinegar. If the liquid gets into the eyes, flush them immediately with clean water for a minimum of 10 minutes and seek medical attention.
23. Do not use for any purpose other than described in this user's guide.
24. Do not attempt to use the charger with any other product nor attempt to charge this product with another charger. **Use only the charger model AD-2120-UL supplied with this appliance manufactured by Techworld Industries.**
25. "Ni-Cd" battery must be recycled or disposed of properly.
26. Turn off all controls before unplugging the unit.

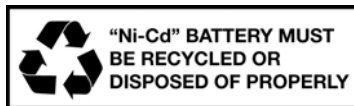

SAVE THESE INSTRUCTIONS

For Household Use Only

OPERATING INSTRUCTIONS cont.

TROUBLESHOOTING GUIDE

PROBLEM	POSSIBLE REASON	POSSIBLE SOLUTION
HAND VACUUM WILL NOT OPERATE	<ol style="list-style-type: none"> 1. Batteries discharged. 2. No power in electrical outlet supplying transformer. 3. Unit needs servicing. 	<ol style="list-style-type: none"> 1. Charge unit. 2. Check fuse or breaker. Replace fuse/reset breaker. 3. Call: 1 (800) 798-7398
HAND VACUUM WILL NOT PICK-UP OR SUCTION POWER IS WEAK	<ol style="list-style-type: none"> 1. Dust cup container is full. 2. Dust cup filter needs cleaning. 3. Unit needs recharging. 	<ol style="list-style-type: none"> 1. Empty dust cup container 2. Remove dust cup filter and check for object(s) in air duct and remove. Clean or replace dust cup filter. 3. Charge unit.
DUST ESCAPING FROM HAND VACUUM	<ol style="list-style-type: none"> 1. Dust cup container is full. 2. Dust cup filter and separator housing are not installed correctly. 3. Puncture/hole in dust cup filter. 	<ol style="list-style-type: none"> 1. Empty dust cup container. 2. Review dust cup filter and separator housing installation. 3. Replace dust cup filter.
HAND VACUUM BRUSHES OR OTHER TOOL WILL NOT PICK-UP	<ol style="list-style-type: none"> 1. Extension hose clogged. 2. Dust cup container is full. 	<ol style="list-style-type: none"> 1. Remove hose and/or bushes. Remove obstruction from hose or other tool. 2. Empty and clean dust cup container.

REPLACEMENT FILTERS

Replacement dust cup filter SKU# XSB745

Replacement battery pack SKU# XBP746

for Model SV745

Call: 1-866-98SHARK (1-866-987-4275)
Monday to Friday 8:30 A.M. - 5:00 P.M. Eastern Standard Time
or

visit our website: www.sharkvac.com

FOR TECHNICAL SUPPORT

In U.S.: 800-798-7398
Monday to Friday 8:30 A.M. - 5:00 P.M. Eastern Standard Time

Please Note

The Dust Cup Filter is washable. It should, however, be replaced every three (3) months to ensure peak performance of your vacuum.

Important

Make sure that Dust Cup Filter is completely dry before re-installing back in the hand vacuum.

OPERATING INSTRUCTIONS cont.

Battery Pack Replacement & Disposal

This vacuum cleaner contains a nickel-cadmium (Ni-Cd) batteries. Batteries must be recycled or disposed of properly. Call your nearest recycling center for information on the recycling and disposal of nickel-cadmium (Ni-Cd) batteries.

If uncertain as to how to remove the battery pack, we suggest you take your wet/dry hand vacuum to a reputable small appliance service technician to have this service preformed.

The battery pack of your SV745 is replaceable, however care should be taken when doing so. Follow these steps when replacement is required:

1. Open the battery pack compartment by removing the single Phillips head screw located in the recess at the rear of the unit. **NEVER** open the battery compartment except to change the battery pack when required.
2. Remove battery compartment cover. Set aside battery compartment cover with the screw.
3. Carefully detach the two (2) electrical connectors from the battery pack by pulling straight out from the battery pack.
4. Lift out the battery pack and set aside.
5. Insert the new battery pack and re-connect the terminals by pushing lead wires onto battery tabs.
6. Tuck the wiring inside the battery compartment so that the wiring does not interfere with the battery compartment cover when it is replaced.
7. Re-install the battery compartment cover by sliding it over the battery towards the front of the unit, making sure that the front snap engages the body of the unit.
8. Replace the battery compartment cover screw.

WARNING: NEVER use ordinary batteries for replacement, as these may leak and damage your vacuum cleaner. Use only battery pack XBP746 provided by EURO-PRO Operating LLC for replacement.

CAUTION: NEVER use the unit without the battery compartment cover in place.

NOTE: Any other servicing should be performed by an authorized service representative.



"Ni-Cd" BATTERY MUST BE RECYCLED OR DISPOSED OF PROPERLY

CAUTION

- Use only with the battery pack supplied with the unit.
- Do not attempt to remove the battery pack from the unit to charge it.
- Never attempt to throw the battery pack or unit into a fire or incinerate it.
- Do not attempt to remove or damage the battery casing.
- Battery must be recycled or disposed of properly at the end of it's service life.
- Any other servicing should be performed by an authorized service representative.

Hints for Spot Cleaning Carpets

Note: Before spot cleaning your carpet, test for color fastness. Dampen a white cloth with the cleaning solution that you will be using and test a small area in a closet or under a piece of furniture. Gently rub the cloth over the area. Check each color for bleeding. If the cloth remains white, it should be safe to clean the carpet or upholstery. When using commercial pre-cleaners spot removers, follow manufacturers instructions and follow this procedure with our Wet/Dry Vac.

1. Apply the pre-cleaner spot remover to the carpet as per manufacturers instructions.
2. Using the Wet/Dry vacuum, suck the pre-cleaner spot remover liquid from the carpet.
3. Spray the same area with water.
4. Vacuum again to remove the water.
5. Repeat steps 3 and 4 again if necessary.
6. Empty the dust cup.
7. If you still see that the pre-cleaner has not been completely removed, repeat steps 3 and 4 again.
8. If the stain has not been removed, repeat steps 1 to 6 again.

NOTE: Pre-cleaner spot removers sometimes do not remove tough stains. Please use a professional carpet cleaning service if such is the case.

Wall Mounting Bracket

1. Make sure that the intended wall area for the wall mounting bracket to be drilled is free from any hidden electrical wires, water pipes and gas lines.
2. Select an appropriate place close to a wall power outlet (120V., 60 Hz).
3. Do not mount near direct sunlight, near a heat source or outdoors.
4. Select an appropriate drill type for the material to be drilled.
5. Carefully measure and mark the location of all bracket holes and then drill holes and screw the wall mounting bracket onto the wall.

Shark™
CORDLESS hand vac
wet/dry

Model SV745
14.4 V DC

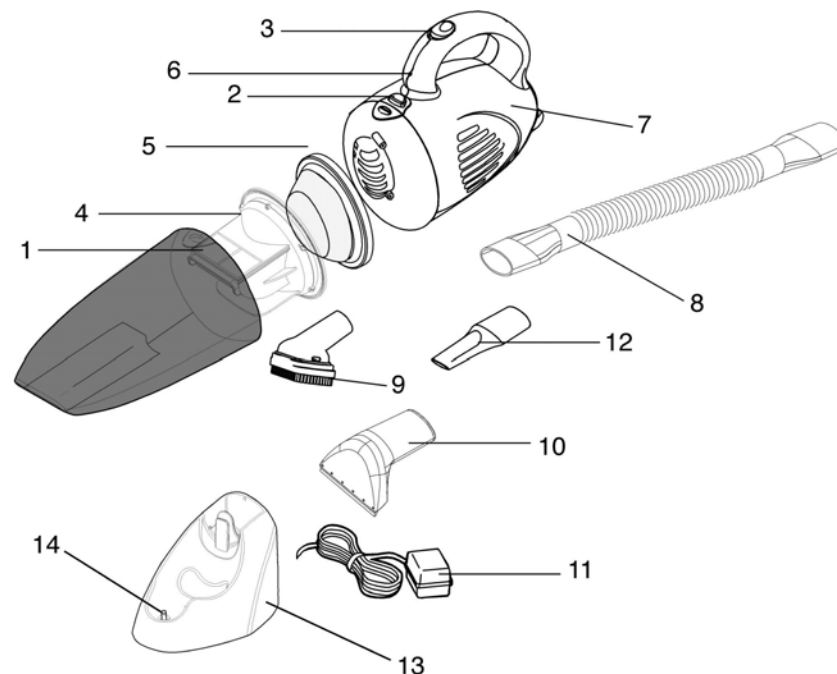

- | | |
|-----------------------------|----------------------|
| 1. Dust Cup (Container) | 8. Extension Hose |
| 2. Dust Cup Release Button | 9. Convertible Brush |
| 3. On / Off Switch | 10. Squeegee Nozzle |
| 4. Separator Housing | 11. Charging Adapter |
| 5. Dust Cup Filter | 12. Crevice Tool |
| 6. Charging Light Indicator | 13. Recharging Stand |
| 7. Main Unit | 14. Charging Jack |

NOTE: Cordless Wet/Dry Hand Vacuum Model SV745 is shipped with the batteries uncharged. Charging of the unit for 20 hours prior to first use is required.

OPERATING INSTRUCTIONS

Before Use

1. This cordless wet/dry hand vacuum is powered by rechargeable nickel-cadmium batteries. Before using the vacuum, charge the vacuum cleaner for a minimum of 20 hours.

NOTE: Ensure that the On/Off switch is in the "Off" position before charging.

NOTE: Peak performance may only be realized after the unit has been charged and discharged two (2) or three (3) times.

IMPORTANT: To maintain peak performance of your cordless hand vacuum, it is recommended that the unit be fully discharged, then completely re-charged at least once a month.

2. Store the vacuum cleaner in the charging base when not in use so that it is always charged and ready to use.

Charging Your Vacuum Cleaner

1. Place the charging base near an electrical power outlet (120 V., 60 Hz.) and plug in the charging adapter's jack into the charging base.
2. Plug the charger into wall outlet.
3. Place the unit in the charging base. The charging indicator light will shine red to indicate that the vacuum cleaner is properly positioned in the charging base and that the unit is being charged. (See Fig. 1)

NOTE: Ensure that the On/Off switch is in the "Off" position before charging.

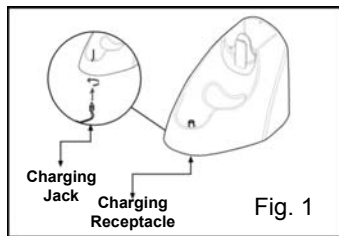

Assembly

Note: Dust cup filter and separator must always be used when operating the hand vacuum.

1. To open the dust cup compartment, push the dust cup release button and remove the dust cup container. (Fig. 2)
2. Verify that the dust cup filter and the separator housing are inside, then re-attach the dust cup container to the wet/dry hand vacuum. (Fig. 3 & Fig. 4)

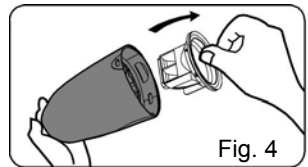
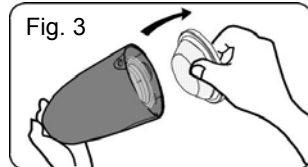
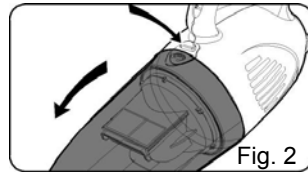

3. To attach the convertible brush, crevice tool or squeegee nozzle to the wet/dry hand vacuum, push the attachment into the suction hole in the front of the dust container. (Fig. 5)

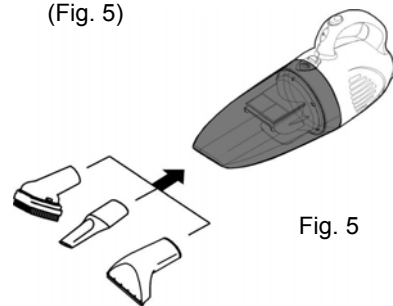

OPERATING INSTRUCTIONS cont.

Assembly (cont.)

4. To use the extension hose with convertible brush, crevice tool or squeegee nozzle, push the smaller end of extension hose into the suction hole, then push the selected accessory into the other end. (Fig. 6)

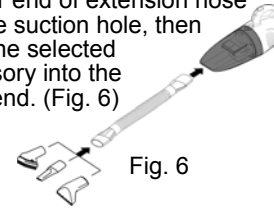

Using Your Cordless Wet/Dry Vacuum

1. Remove the vacuum cleaner from the charging base
2. To start the unit, push the "On/Off" switch to the "On" position.
3. To stop the vacuum cleaner, slide the "On/Off" switch to the "Off" position.

Crevice Tool

A crevice tool is provided for cleaning narrow, hard to reach places.



Convertible Brush

A convertible brush is provided for cleaning upholstery, furniture, etc.



Squeegee Nozzle

A squeegee nozzle is provided for picking up any liquid spills.



IMPORTANT: WET PICK-UP

When using this vacuum for wet pick-up, **NEVER** fill past the "MAX" level mark on the dust cup housing. Maximum capacity (liquid) is 6 US Fl. Oz. (180 ml). **Never** tip the unit upward past horizontal when vacuuming liquids. Keep suction inlet pointed downward. Always empty the dust cup after using the vacuum to pick up liquids.

Changing & Cleaning the Dust Cup Filter
To achieve the best performance, empty the dust cup container and clean the dust cup filter after each use.

1. To remove the dust cup container, press down on the dust cup release button and pull off the dust cup container. (Fig. 7)
2. Pull out the dust cup filter. (Fig. 8)
3. Pull out the separator housing. (Fig. 9)

Changing & Cleaning the Dust Cup Filter (cont)

4. Empty the dust from the dust cup container. (See Fig. 10)
5. Rinse the dust cup filter in cold water, and then wait until it dries completely before replacing it back into the dust cup container. Do **not** use a washing machine to clean the dust cup filter. Do not use a hair dryer to dry it. **Air dry only.**
6. To empty liquids from the dust cup, follow same instructions as above. Do not let liquids in dust cup go over the "MAX" level on the dust cup. (Fig. 11 & Fig. 12)
7. Replace the separator housing and the dust cup filter carefully into the dust cup compartment. **NEVER operate vacuum cleaner without the separator housing and the dust cup filter in place.**
8. Attach the dust cup container to the cordless vacuum.

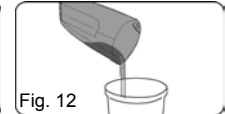
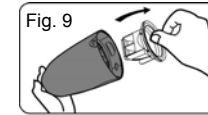
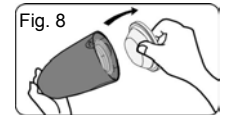
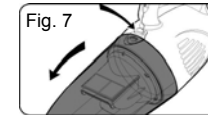

NOTE: When vacuuming up liquids, ensure that you do not go over the "MAX" level on the dust cup. Capacity is 6 US Fl. Oz. (180 ml.).

NOTE: It is recommended that the dust cup filter be replaced every three (3) months to ensure peak performance of the unit.

CAUTION: The suction hole must be open and free of any obstructions at all times. Otherwise, the motor will overheat and could become damaged.